

Data Sheet



Article number: 51803559000010

Description: Vibration damper GP-QP 200x160
NR shore 57

Measures

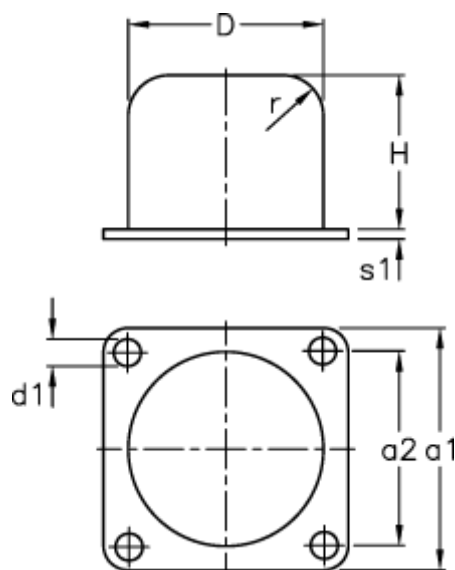

a1 = 250
a2 = 200
D = 200
d1 = 13.0
H = 160
Load capacity F (kN) = 375.0
Load capacity f (mm) = 38
Load capacity W (J) = 8800

r = 40.0
s1 = 8